

KOMATSU®

WA600-6

HORSEPOWER

Gross: 396 kW 530 HP @ 1800 rpm

Net: 393 kW 527 HP @ 1800 rpm

BUCKET CAPACITY

6.4-7.0 m³ 8.4-9.2 yd³

ecot3

WA
600

WHEEL LOADER



Photo may include optional equipment.

WALK-AROUND

High Productivity & Low Fuel Consumption

- High performance SAA6D170E-5 engine
- Low fuel consumption
- Dual-mode engine power select system
- Automatic transmission with shift timing select system
- Lock-up Torque Converter
- Variable displacement piston pump & CLSS
- Increased bucket capacity
- Long wheelbase

See pages 4 and 5.

Excellent Operator Environment

- Automatic transmission with ECMV
- Low-noise designed cab
- Electronic controlled transmission lever
- Modulated clutch system
- Engine RPM set system with auto decel (Optional)
- “EPC” (Electronic Pilot Control) levers
- Pillar-less large ROPS/FOPS integrated cab
- Easy entry/exit, front-hinged door
- “AJSS” (Advanced Joystick Steering System) (Optional)

See pages 8 and 9.



Harmony with Environment

- EPA Tier 3 and EU Stage 3A emissions certified
- Low exterior noise
- Low fuel consumption

Increased Reliability

- Reliable Komatsu designed and manufactured components
- Sturdy main frame
- Maintenance-free, fully hydraulic, wet disc service and parking brakes
- Hydraulic hoses use flat face O-ring seals
- Cathion electrodeposition process is used to apply primer paint
- Powder coating process is used to apply main structure paint
- Sealed DT connectors for electrical connections

See page 6.

HORSEPOWER

Gross: 396 kW 530 HP @ 1800 rpm

Net: 393 kW 527 HP @ 1800 rpm

BUCKET CAPACITY

6.4–7.0 m³ 8.4-9.2 yd³



Photo may include optional equipment.

Easy Maintenance

- “EMMS” (Equipment Management Monitoring System)
- “VHMS” (Vehicle Health Monitoring System) (Optional)
- Ease of radiator cleaning
- Modular radiator core system

See page 7.

HIGH PRODUCTIVITY AND LOW FUEL CONSUMPTION



High Performance SAA6D170E-5 Engine

Electronic Heavy Duty Common Rail fuel injection system provides optimum combustion of fuel. This system also provides fast throttle response to match the machine's powerful tractive effort and fast hydraulic response.

Net: 393 kW 527 HP

Low Emission Engine

This engine is EPA Tier 3 and EU Stage 3A emissions certified, without sacrificing power or machine productivity.

Low Fuel Consumption

The fuel consumption is reduced greatly because of the low-noise, high-torque engine and the large-capacity torque converter with maximum efficiency in the low-speed range.

Dual-mode Engine Power Select System

This wheel loader offers two selectable operating modes—E and P. The operator can adjust the machine's performance with the selection switch.

- **E Mode:** This mode provides maximum fuel efficiency for general loading.
- **P Mode:** This mode provides maximum power output for hard digging operation or hill climb.



Dual mode engine power selection switch



The eco indicator will help an operator to promote energy saving.

Automatic Transmission with Mode Select System

This operator controlled system allows the operator to select manual shifting or two levels of automatic shifting (low, and high).

Auto L mode is for fuel saving operation with the gear shift timing set at lower speeds than Auto H mode. Therefore Auto L mode keeps the engine in a relatively low rpm range for



fuel conservation while yielding adequate tractive force by depressing the accelerator pedal.

Shift mode selection switch

Lock up clutch switch

Lock-up Torque Converter

The Komatsu designed lock-up torque converter provides increased production efficiency, reduced cycle times and optimum fuel savings in load & carry or hill-climb operations. This optional feature allows the operator to activate the system on/off with a switch located on the right-side control panel.

Variable Displacement Piston Pump & CLSS

New design variable displacement piston pump combined with the Closed-center Load Sensing System delivers hydraulic flow just as the job requires preventing wasted hydraulic pressure. Minimized waste loss contributes to better fuel economy.

- **New Variable Displacement Piston Pump:** The pump delivers only necessary amounts minimizing waste loss.

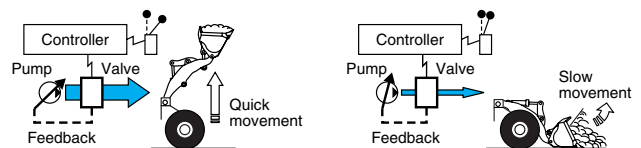

- **Fixed Displacement Piston Pump:** The pump delivers the maximum amount at any time and the unused flow is disposed.

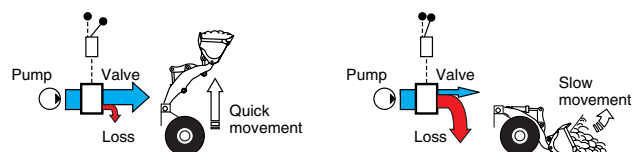



Increased Bucket Capacity Matches with One Class Higher Dump Truck



The WA600 can load 60t (70 Short ton) trucks with standard boom. The WA600-3 required an optional high lift boom and 6.4m³ bucket. The WA600-6 maintains good visibility for loading because of increased operator cab height.

Dumping Clearance: 3995 mm 13'1"
Dumping Reach: 1800 mm 5'11"
 (6.4 m³ 8.4 yd³ spade nose bucket with tooth)

Long Wheelbase/Articulation Angle of 43°

The widest tread in class and the long wheelbase provide improved machine stability in both longitudinal and lateral directions. Since the articulation angle is 43°, the operator can work efficiently even in the tightest job sites.

Tread	2650 mm	8'8"
Wheelbase	4500 mm	14'9"
Minimum turning radius (center of outside tire)	7075 mm	23'3"

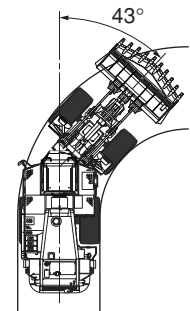

INCREASED RELIABILITY

Komatsu Components

Komatsu manufactures the engine, torque converter, transmission, hydraulic units, electric parts, on this wheel loader. Komatsu loaders are manufactured with an integrated production system under a strict quality control system.

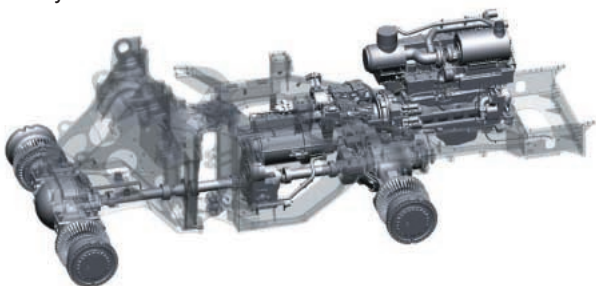

Wet Multi-disc Brakes and Fully Hydraulic Braking System

mean lower maintenance costs and higher reliability. Wet disc brakes are fully sealed. Contaminants are kept out, reducing wear and maintenance. Brakes require no adjustments for wear, meaning even lower maintenance. The new parking brake is also an adjustment-free, wet multi-disc for high reliability and long life.

Added reliability is designed into the braking system by the use of two independent hydraulic circuits. Provides hydraulic backup should one of the circuits fail.

Fully hydraulic brakes mean no air system to bleed, or the condensation of water in the system that can lead to contamination, corrosion, and freezing.

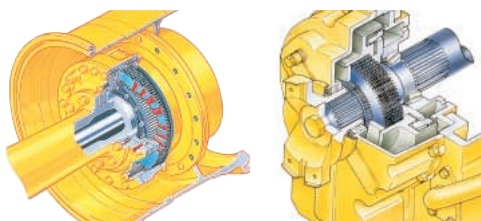

Sweeper Wing (Large Size Tire Guard)

To prevent tire damage, the WA600 provides a Sweeper Wing (Large Size Tire Guard) on both sides of bucket.

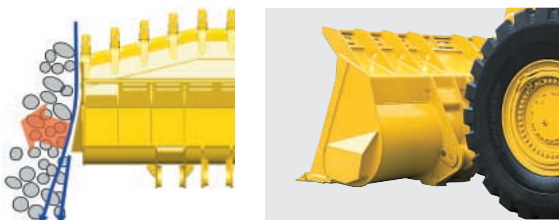

High-rigidity Frames and Loader Linkage

The front and rear frames and the loader linkage have more torsional rigidity to secure resistance against increased stress due to the use of a larger bucket. Frame and loader linkage are designed to accommodate actual working loads, and simulated computer testing proves its strength.

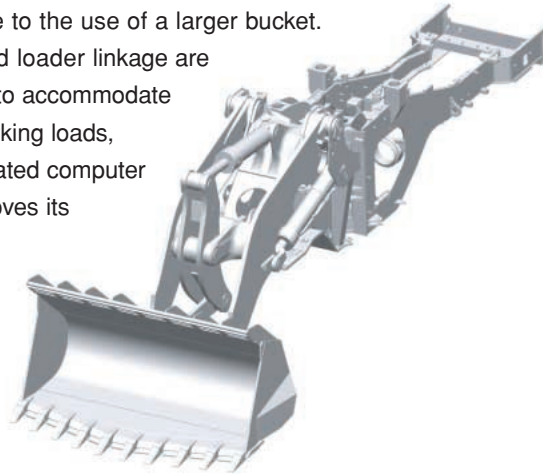

Flat Face-to-face O-ring Seals

Flat face-to-face O-ring seals are used to securely seal hydraulic hose connections and to prevent oil leakage. In addition, buffer rings are installed to the head side of the all-hydraulic cylinders to lower the load on the rod seals and maximize the reliability.

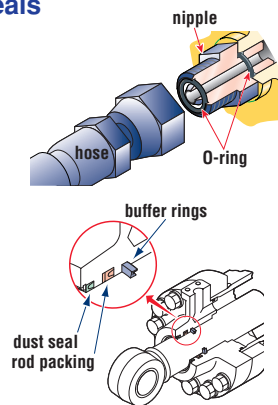

Cathion Electrodeposition Primer Paint/ Powder Coating Final Paint

Cathion electrodeposition paint is applied as a primer paint and powder coating is applied as topcoat to the exterior sheet metal parts. This process results in a beautiful rust-free machine, even in the most severe environments. Some external parts are made of plastic providing long life and high impact resistance.

Sealed DT Connectors

Main harnesses and controller connectors are equipped with sealed DT connectors providing high reliability, water resistance and dust resistance.



EASY MAINTENANCE



Photo may include optional equipment.

EMMS (Equipment Management Monitoring System)

Monitor is mounted in front of the operator for easy viewing, allowing the operator to easily check gauges and warning lights.



Maintenance Control and Troubleshooting Functions

- **Action code display function:** If abnormality occurs, the monitor displays action details on the character display at the bottom center of the monitor.
- **Monitor function:** Controller monitors engine oil level, pressure, coolant temperature, air cleaner clogging, etc. If controller finds abnormalities, the error is displayed on LCD.
- **Replacement time notice function:** Monitor informs replacement time of oil and filters on LCD when replacement intervals are reached.
- **Trouble data memory function:** Monitor stores abnormalities for effective troubleshooting.

Modular Radiator Core System

The modular radiator core is easy to replace without removing the entire radiator assembly.

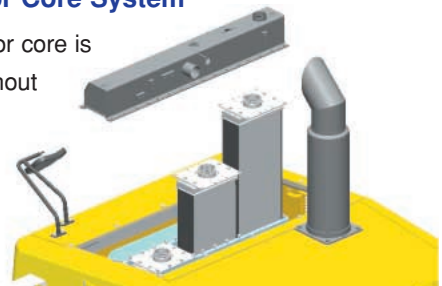

Ease of Radiator Cleaning

If the machine is operating in adverse conditions, the operator can reverse the hydraulic cooling fan from inside the cab by turning a switch on the control panel.



VHMS (Vehicle Health Monitoring System) (Optional)

VHMS is a management system for large equipment for use in mining, which enables detailed monitoring of fleet via satellite communications. Komatsu and distributors can analyze "vehicle health" and other operating conditions and provide the information to job site using the internet from a remote location on a near-real time basis.

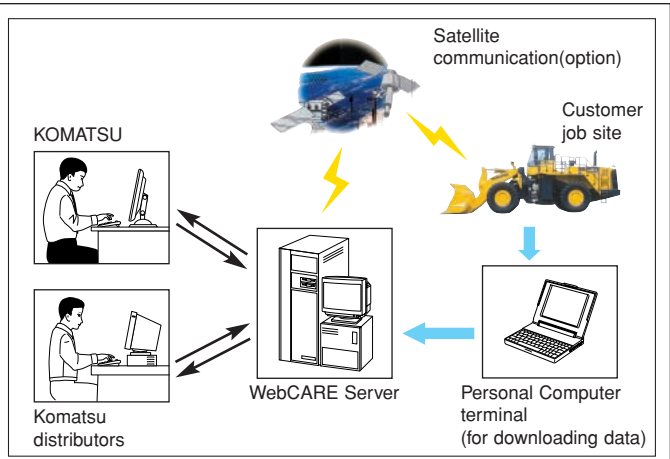

OPERATOR ENVIRONMENT

Easy Operation

Automatic Transmission with ECMV

Automatic transmission with ECMV automatically selects the proper gear speed based on travel speed, engine speed, and other travel conditions. The ECMV (Electronically Controlled Modulation Valve) system engages the clutch smoothly to prevent lags and shocks when shifting. This system provides efficient machine operation and a comfortable ride.

● **Kick-down**

switch: Consider this valuable feature for added productivity. With the touch of a finger, the kick-down switch

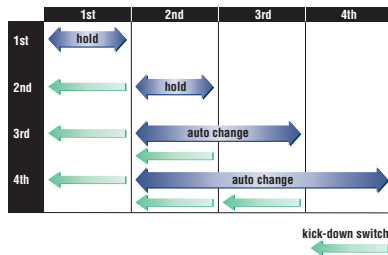

automatically downshifts from second to first when beginning the digging cycle. It automatically upshifts from first to second when the direction control lever is placed in reverse. This results in increased rim pull for better bucket penetration and reduced cycle times for higher productivity.

- **Hold switch:** Auto shift is selected and if the operator turns on this switch when the lever is at the 3rd or 4th gear speed position, the transmission is fixed to that gear speed.

Electronic Controlled Transmission Lever

Easy shifting and directional changes with Komatsu two-lever electronic shifting. Change direction or shift gears with a touch of the fingers without removing the shifting hand from the steering wheel. Solid state electronics and conveniently located direction and gear shift controls make this possible. Automatic shifts in ranges two through four keep production high and manual shifting at a minimum.

Modulated Clutch System

The Modulated Clutch System controls the tractive effort with left brake pedal from 100% to 20% of the converter output torque.

- Useful for smooth speed reduction when approaching dump trucks for loading.
- Easy control of tire slippage.
- Reduction of shocks in shifting from forward to reverse.

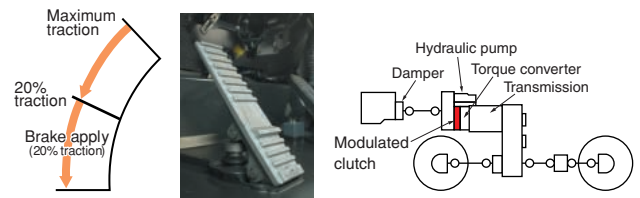

Engine RPM Set System with Auto Decel (Optional)

Engine Low idle RPM can be easily preset using a push button switch. The system provides auto decel for better fuel consumption.



- 1:ECSS 2:Remote Boom positioner switch
 3:Remote bucket digging angle control switch
 4:RPM set (On/Off) (option) 5:RPM idle set (option)
 6:Semi-auto digging system (option) 7:Boom control 8:Bucket control

Steering Wheel with Telescopic/Tilt Column

The operator can tilt and telescope the steering column to provide a comfortable working position.

Comfortable Operation

EPC (Electronic Pilot Control) Levers

The finger control EPC work equipment levers have light operating effort and short stroke facilitating easy operation. The operator's comfort is further increased by the full large size adjustable arm rests. Combined with CLSS, this system allows the following new functions for easy and efficient operation:

- Remote Boom Positioner with shockless stop function:** The highest and lowest position of the bucket can be set from cab to match any truck body. Once the positioner is set, the bucket is smoothly stopped at desired position with no shock.
- Remote bucket digging angle control:** The digging bucket angle can be easily set from cab to match of ground condition.
- Semi-auto digging system (optional):** Bucket tilt operation can be automatically done when digging.

AJSS (Advanced Joystick Steering System) (Optional)

AJSS is a feedback steering system which has been incorporated to allow steering and forward and reverse selection to be controlled by wrist and finger control. With the feedback function added, the machine steering angle is defined exactly the same angle as the lever tilt angle.

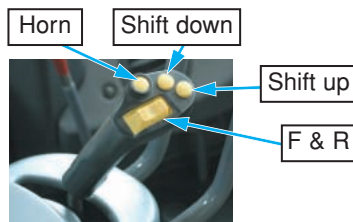

Low-noise Design

Noise at operator's ear noise level : 76 dB(A)
Dynamic noise level (outside): 113 dB(A)

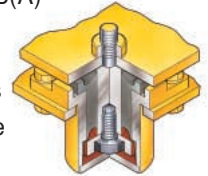

The large cab is mounted with Komatsu's unique ROPS/FOPS viscous mounts. The low-noise engine, hydraulically driven fan, and hydraulic pumps are mounted with rubber cushions, and the cab sealing is improved to provide a quiet, low-vibration, dustproof pressurized, and comfortable operating environment. Also, exterior noise is lowest in this class.



Pillar-less Large Cab

A wide pillar-less flat glass provides excellent front visibility. The wiper arm covers a large area to provide great visibility even on rainy days.

The cab area is the largest in its class providing maximum space for the operator.

Rear Access Stairs

For the purpose of safely boarding and exiting machine, rear access stairs with safety handrail is provided.

The step width, clearance, and the step angle have been designed for safety climbing both up and down. A step light provides light for night boarding.



SPECIFICATIONS



ENGINE

ModelKomatsu SAA6D170E-5
 TypeWater-cooled, 4-cycle
 AspirationTurbocharged, aftercooled, cooled EGR
 Number of cylinders6
 Bore x stroke170 mm x 170 mm 6.69" x 6.69"
 Piston displacement23.15 ltr 1413 in³
 Governorall-speed, electronic
 Horsepower
 SAE J1995Gross 396 kW 530 HP
 ISO 9249/SAE J1349*Net 393 kW 527 HP
 Rated rpm1800 rpm
 Fan drive method for radiator coolingHydraulic
 Fuel systemDirect injection
 Lubrication system:
 MethodGear pump, force-lubrication
 FilterFull-flow type
 Air cleanerDry type with double elements and
 dust evacuator, plus dust indicator

*Net horsepower at the maximum speed of radiator cooling fan is 374 kW 502 HP.

EPA Tier 3 and EU Stage 3A emissions certified.



TRANSMISSION

Torque converter:
 Type3-element, single-stage, double-phase
 Transmission:
 TypeFull-powershift, planetary type
 Travel speed: km/h mph
 Measured with 35/65-33 tires

() : Look-up clutch ON

	1st	2nd	3rd	4th
Forward	6.7 4.2	11.7 7.3	20.3 12.6	33.8 21.0
	—	(12.4 7.7)	(21.7 13.5)	(37.7 23.4)
Reverse	7.3 4.5	12.8 8.0	22.0 13.7	37.0 23.0



AXLES AND FINAL DRIVES

Drive systemFour-wheel drive
 FrontFixed, full-floating
 RearCenter-pin support, full-floating,
 26° total oscillation
 Reduction gearSpiral bevel gear
 Differential gearConventional type
 Final reduction gearPlanetary gear, single reduction



BRAKES

Service brakesHydraulically actuated,
 wet disc brakes actuate on four wheels
 Parking brakeWet disc brake
 Emergency brakeParking brake is commonly used



STEERING SYSTEM

TypeArticulated type, full-hydraulic power steering
 Steering angle43° each direction
 Minimum turning radius at
 the center of outside tire7075 mm 23'3"



HYDRAULIC SYSTEM

Steering system:
 Hydraulic pumpPiston pump
 Capacity163 ltr/min 43.1 U.S. gal/min at rated rpm
 Relief valve setting34.3 MPa 350 kgf/cm² 4,980 psi
 Hydraulic cylinders:
 TypeDouble-acting, piston type
 Number of cylinders2
 Bore x stroke115 mm x 510 mm 4.5" x 20"

Loader control:
 Hydraulic pumpPiston pump
 Capacity239 + 239 ltr/min 63.1 + 63.1 U.S. gal/min
 at rated rpm
 Relief valve setting34.3 MPa 350 kgf/cm² 4,980 psi
 Hydraulic cylinders:
 TypeDouble-acting, piston type
 Number of cylinders—bore x stroke:
 Lift cylinder2- 200 mm x 1067 mm 7.9" x 42"
 Bucket cylinder1- 225 mm x 776 mm 8.9" x 30.6"
 Control valve2-spool type
 Control positions:
 BoomRaise, hold, lower, and float
 BucketTilt-back, hold, and dump
 Hydraulic cycle time (rated load in bucket)
 Raise9.3 sec
 Dump2.3 sec
 Lower (Empty)4.1 sec



SERVICE REFILL CAPACITIES

Cooling system147 ltr 38.8 U.S. gal
 Fuel tank718 ltr 189.7 U.S. gal
 Engine86 ltr 22.7 U.S. gal
 Hydraulic system443 ltr 117.0 U.S. gal
 Axle (each front and rear)155 ltr 41.0 U.S. gal
 Torque converter and transmission83 ltr 21.9 U.S. gal



BUCKET SELECTION GUIDE

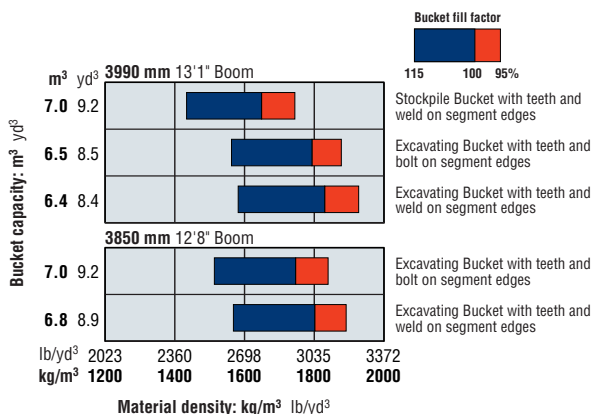

 **DIMENSIONS**

Measured with 35/65-33-36PR(L-4) tires

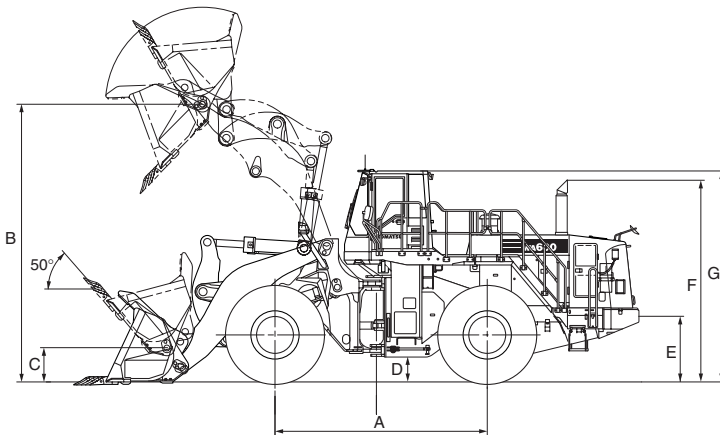

		3990 mm 13'1"	3850 mm 12'8"
		Boom	Boom
	Tread	2650 mm 8'8"	
	Width over tires	3540 mm 11'9"	
A	Wheelbase	4500 mm 14'9"	
B	Hinge pin height, max. height	5885 mm 19'4"	5665 mm 18'7"
C	Hinge pin height, carry position	720 mm 2'4"	670 mm 2'3"
D	Ground clearance	525 mm 1'9"	
E	Hitch height	1385 mm 4'7"	
F	Overall height, top of the stack	4270 mm 14'0"	
G	Overall height, ROPS cab	4460 mm 14'8"	

	3990 mm 13'1" Boom			3850 mm 12'8" Boom	
	Excavating Buckets		Stockpile Bucket	Excavating Buckets	
	Spade nose Teeth and WSE *1	Straight edge Teeth and BSE *2	Spade nose Teeth and WSE *1	Spade nose Teeth and WSE *1	Straight edge Teeth and BSE *2
Bucket capacity: heaped	6.4 m ³	6.5 m ³	7.0 m ³	7.0 m ³	7.0 m ³
	8.4 yd ³	8.5 yd ³	9.2 yd ³	9.2 yd ³	9.2 yd ³
struck	5.3 m ³	5.4 m ³	5.8 m ³	5.8 m ³	5.8 m ³
	6.9 yd ³	7.1 yd ³	7.6 yd ³	7.6 yd ³	7.6 yd ³
Bucket width	3685 mm 12'1"	3685 mm 12'1"	3685 mm 12'1"	3685 mm 12'1"	3685 mm 12'1"
Bucket weight	5115 kg 11,280 lb	4735 kg 10,440 lb	5255 kg 11,590 lb	5245 kg 11,570 lb	4865 kg 10,730 lb
Dumping clearance, max. height and 45° dump angle*3	3995 mm 13'1"	4180 mm 13'9"	3945 mm 12'11"	3730 mm 12'3"	3905 mm 12'10"
Reach at max. height and 45° dump angle*3	1800 mm 5'11"	1610 mm 5'3"	1850 mm 6'1"	1885 mm 6'2"	1690 mm 5'7"
Reach at 2130 mm (7') clearance and 45° dump angle	3015 mm 9'11"	2875 mm 9'5"	3050 mm 10'0"	2900 mm 9'6"	2775 mm 9'1"
Reach with arm horizontal and bucket level	4135 mm 13'7"	3870 mm 12'8"	4205 mm 13'9"	4065 mm 13'4"	3800 mm 12'6"
Operating height (fully raised)	7925 mm 26'0"	7925 mm 26'0"	7995 mm 26'3"	7775 mm 25'6"	7775 mm 25'6"
Overall length	11985 mm 39'4"	11725 mm 38'6"	12055 mm 39'7"	11870 mm 38'11"	11610 mm 38'1"
Loader clearance circle (bucket at carry, outside corner of bucket)	17000 mm 55'9"	17060 mm 56'0"	17040 mm 55'11"	16875 mm 55'4"	16920 mm 55'6"
Digging depth: 0°	130 mm 5.1"	135 mm 5.3"	130 mm 5.1"	130 mm 5.1"	140 mm 5.5"
	515 mm 1'8"	480 mm 1'7"	530 mm 1'9"	530 mm 1'9"	495 mm 1'7"
Static tipping load: straight	34200 kg 75,400 lb	34580 kg 76,240 lb	34060 kg 75,090 lb	35400 kg 78,040 lb	35780 kg 78,880 lb
	28500 kg 62,830 lb	28880 kg 63,670 lb	28360 kg 62,520 lb	29500 kg 65,040 lb	29880 kg 65,870 lb
Breakout force	387 kN 39500 kgf 87,080 lb	448 kN 45680 kgf 100,710 lb	375 kN 38200 kgf 84,220 lb	378 kN 38600 kgf 85,100 lb	433 kN 44150 kgf 97,340 lb
	52700 kg 116,180 lb	52320 kg 115,340 lb	52840 kg 116,490 lb	52900 kg 116,620 lb	52500 kg 115,740 lb

*1 Weld on segment edges. *2 Bolt on segment edges. *3 At the end of tooth or B.O.C.

All dimensions, weights, and performance values based on SAE J732c and J742b standards.

Static tipping load and operating weight shown include lubricant, coolant, full fuel tank, ROPS cab, and operator. Machine stability and operating weight affected by counterweight, tire size, and other attachments.

Apply the following weight changes to operating weight and static tipping load.



WEIGHT CHANGES

Tires or attachments	Operating weight		Tipping load straight 3990 mm Boom (3850 mm Boom)		Tipping load full turn 3990 mm Boom (3850 mm Boom)		Width over tires		Ground clearance		Change in vertical dimensions	
	kg	lb	kg	lb	kg	lb	mm	ft in	mm	ft in	mm	ft in
	35/65-33-36PR(L-4)	0	0	0 (0)	0 (0)	0 (0)	0 (0)	3540	11'7"	525	1'9"	0
35/65-33-36PR(L-5)	+1000	+2,205	+715 (+745)	+1,575(+1,640)	+595 (+620)	+1,310(+1,365)	3540	11'7"	525	1'9"	0	0'0"
35/65-33-42PR(L-4)	+20	+45	+15 (+15)	+30 (+35)	+10 (+15)	+25 (+30)	3555	11'8"	525	1'9"	0	0'0"
35/65-R33 ★(L-4)	-780	-1,720	-555 (-580)	-1230 (-1280)	-465 (-485)	-1025 (-1065)	3565	11'8"	460	1'6"	-65	-2'6"
35/65-R33 ★(L-5)	-235	-520	-170 (-175)	-375 (-390)	-140 (-145)	-310 (-320)	3565	11'8"	460	1'6"	-65	-2'6"
STD counterweight	0	0	0 (0)	0 (0)	0 (0)	0 (0)						
OPT counterweight	+1000	+2,205	+2380 (+2480)	+5,245(+5,465)	+1985 (+2065)	+4,370(+4,555)						



STANDARD EQUIPMENT

- 2-spool valve for boom and bucket controls
- 3990 mm 13'1" boom
- Alternator, 90 A/24 V
- Auto air conditioner
- Auto shift transmission with mode select system
- Back-up alarm
- Back-up lamp
- Batteries, 200 Ah/12 V x 2
- Boom kick-out
- Bucket positioner
- Directional signal
- Emergency steering (SAE)
- Engine, Komatsu SAA6D170E-5 diesel
- EPC fingertip control levers with automatic leveler and positioner
- Floormat
- Front fender
- Hard water area arrangement (corrosion resister)
- Hydraulic-driven fan with reverse rotation
- Lift cylinders and bucket cylinder
- Lock-up clutch torque converter
- Main monitor panel with EMMS (Equipment Management Monitoring System)
- Radiator mask, lattice type
- Rear access stairs
- Rear defroster (electric)
- Rear under view mirror
- Rearview mirrors
- Rear window washer and wiper
- ROPS/FOPS cab
- Seat belt
- Seat, suspension type with reclining
- Service brakes, wet disc type
- Standard counterweight
- Starting motor, 11.0 kW/24 V x 2
- Steering wheel, tiltable
- Sun visor
- Tires (35/65-33-36PR L4 tubeless) and rims
- Transmission, 4 forward and 4 reverse
- Water separator



OPTIONAL EQUIPMENT

- 3850 mm 12'8" boom
- 3-spool valve
- AJSS (advanced Joystick Steering System)
- AM/FM radio
- AM/FM stereo radio cassette
- Automatic greasing
- Battery disconnect switch
- Brake cooling system
- Bucket teeth (bolt-on type)
- Bucket teeth (tip type)
- Counterweight for log
- Cutting edge (bolt-on type)
- ECSS (Electronically Controlled Suspension System)
- Fire extinguisher
- Limited slip differential (F&R)
- Load meter
- Log grapple
- Optional counterweight
- Ordinary spare parts
- Power train guard
- Rear fender
- Segment edges
- Semi-auto digging system
- Tool kit
- VHMS (Vehicle Health Monitoring System)

www.Komatsu.com

Printed in Japan 201303 IP.SIN

KOMATSU®

CEN00056-04

Materials and specifications are subject to change without notice
KOMATSU is a trademark of Komatsu Ltd. Japan